



MOTOROLA

intelligence everywhere™

Professional Radio

GP688

User Guide

6866542D04

Issue: April 2003

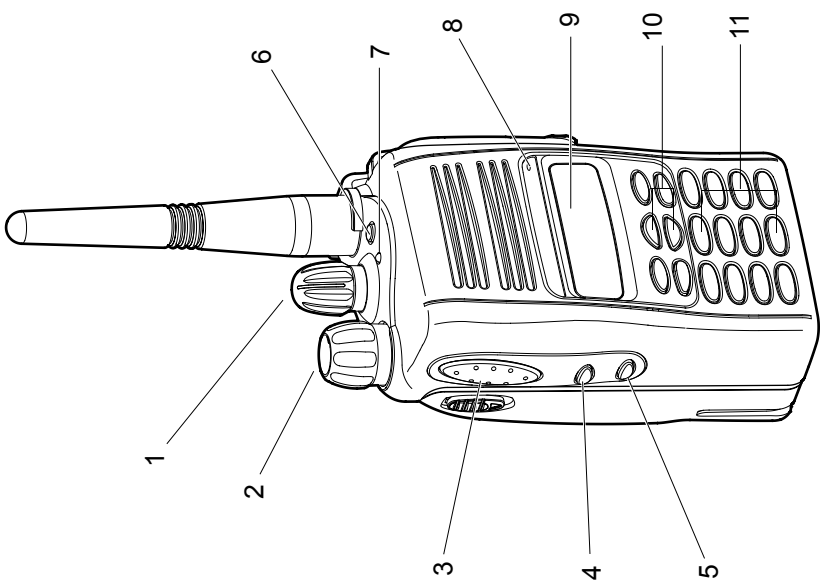
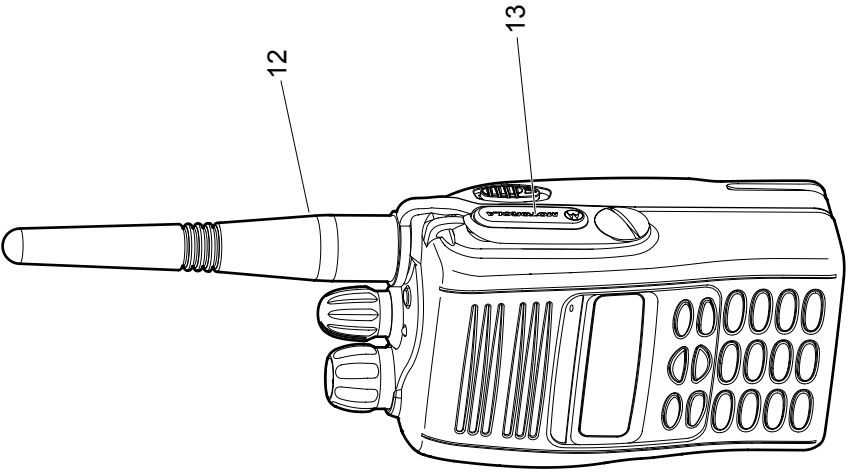

CONTENTS

Radio Overview	3	Radio Operation	18
Operation and Control Functions	3	Turning the Radio On-Off	18
Radio Controls	3	Adjusting the Radio's Volume	18
Programmable Buttons	4	Radio Registration.....	18
Menu Keys	6	Radio Calls	19
Menu Navigation Chart.....	7	Making a Call.....	19
Keypad Keys.....	8	Contact List.....	19
Keypad / Character Table.....	9	User Absent.....	23
LCD Display and Icons	10	Dedicated Calls.....	24
Audio Signal Tones.....	11	Manual Dialling	24
Getting Started	13	Last number Redial	25
Battery Information.....	13	Keypad Edit.....	25
Battery Care and Tips.....	13	Ending a Call.....	26
Recycling or Disposal of Batteries	14	Cancelling a Call	26
Charging the Battery.....	14	Receiving a Call.....	27
Accessory Information	16	Receiving a Call on a OACSU System	27
Attaching the Battery	16	Receiving a Call on a FOACSU System.....	27
Removing the Battery.....	16	Missed Calls	28
Attaching the Antenna	17	Call Diversion	31
Removing the Antenna	17		

Special Calls	33
Short data Messages (SDM)	33
Receiving an SDM	33
Making an SDM	36
Status Calls	38
Making a Status Call	38
Receiving a Status Call	39
Emergency Calls	40
Priority Calls	41
Broadcast Calls	41
DTMF	42
Personality	43
MPT	43
Talkgroup	43
Fixed and Dynamic Groups	43
Conventional Mode	44
Personality Selection	45
Call Progress	47
Call Progress - Sending	47
Call Progress - Receiving	48
Call Progress - Cancelling	49
Call Progress - Ending	49
Notes	50

Computer Software Copyright

The products described in this manual may include copyrighted computer programmes stored in semiconductor memories or other media. Laws in the United States of America and other countries preserve for Motorola Europe and Motorola Inc. certain exclusive rights for copyrighted computer programmes, including the right to copy or reproduce in any form the copyrighted computer programme. Accordingly, any copyrighted computer programmes contained in the products described in this manual may not be copied or reproduced in any manner without the express written permission of the holders of the rights. Furthermore, the purchase of these products shall not be deemed to grant either directly or by implication, estoppel, or otherwise, any licence under the copyrights, patents, or patent applications of the holders of the rights, except for the normal non-exclusive royalty free licence to use that arises by operation of the law in the sale of the product.

RADIO OVERVIEW

This user guide covers the operation of the GP688 Portable Radio.

Before using this radio, refer to the Product Safety and RF Exposure booklet for Portable Two-way Radios 6864117B25_ enclosed with your radio.

OPERATION AND CONTROL FUNCTIONS

Radio Controls

The numbers below refer to the illustrations on the inside front cover.

- 1. Rotary Knob**
Used as a multi-function scroll key and as a channel selector in Conventional mode.
- 2. On-Off / Volume Knob**
Used to turn the radio on or off, and to adjust the radio's volume.
- 3. Push to Talk Button (PTT)**
Press and hold down this button to talk, release it to listen.
- 4. Clear Button (Side Button 1)**
Used to cancel a call, clear down at the end of a call or Carrier Monitor (Conventional mode). Personality button, otherwise programmable.
- 5. Side Button 2**
Personality button, otherwise programmable.
- 6. Top Button** (programmable)
Recommended as Emergency button.
- 7. LED Indicator**
Green: Flashes to indicate NO SERVICE.
Red: On when radio is transmitting.
Red Flashing: When transmitting - battery low.
Red Flashing: When receiving - channel busy (Conventional Mode).
- 8. Microphone**
- 9. LCD Display** (1 Line)
- 10. Menu Keys**
- 11. Keypad**
- 12. Antenna**
- 13. Accessory Connector**
Connects headsets, remote speaker/microphones and other accessories. Replace attached dust cap when not in use.

Programmable Buttons

Several of your radio buttons can be programmed (by Customer Programming Software CPS) to activate the radio features.

The following table shows the features that can be assigned to the Top button and Side Button 2.

Feature	Description
Dedicated Call/ Emergency	To make a call to a pre-determined number. This can be an emergency number, effectively activating an Emergency Call.
Personality	Short cut to the personality menu option to select one of four radio personalities, (e.g. MPT trunking system or conventional system). This will normally be Side Button 2.

Feature	Description
Missed Calls	Short cut to the Missed Call menu option. This is a list of calls received and stored by the radio when you were unable to take the call.
User Absent	To switch the User Absent feature On and Off. This feature is used to indicate to the caller that you are away from your radio and unable to take calls.

Menu Keys

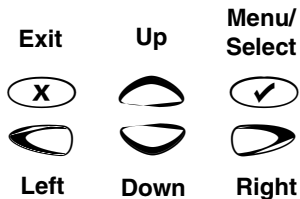

Menu/Select Key

Used to enter the Menu Mode. When you are in the Menu Mode, this key is also used to make menu selections.

Note: When the radio is in the IDLE STATE, pressing any of the six menu keys causes the radio to enter the Menu mode.

Exit Key

Used to move up to the next higher Menu level. When the top level menu is selected this key is used to exit the Menu Mode. Also used to cancel/end calls.

Up Key

Used for scrolling when in Menu Mode.

Down Key

Used for scrolling when in Menu Mode.

Right Key

Used as More key to provide additional information.

Left Key

Used as a destructive backspace key when editing.

Refer to the menu navigation chart for menu selectable features

Menu Navigation Chart

(Refer to Menu Navigation guidelines - lower, left-hand corner of this page)

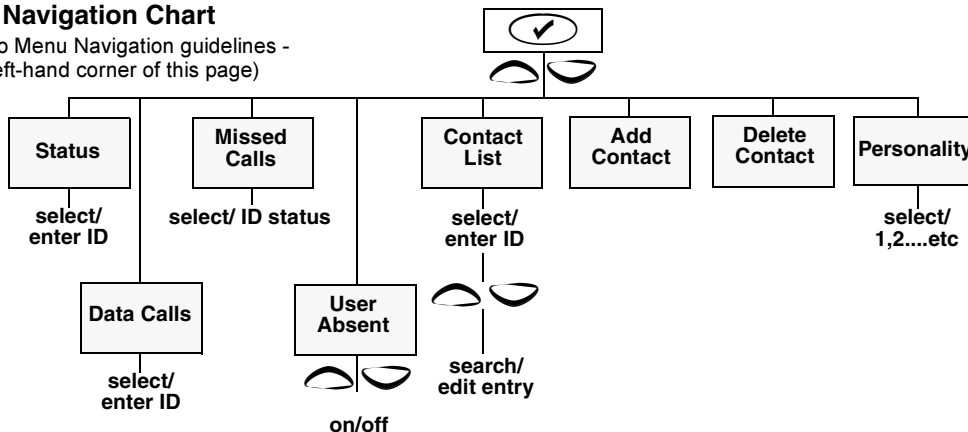

Menu Navigation

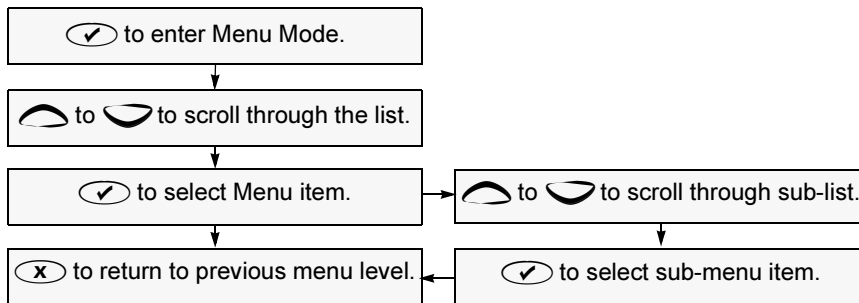

Keypad Keys

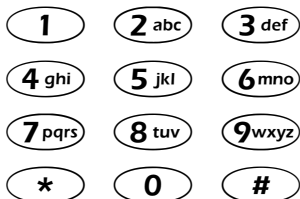

These keys are used when dialling a phone number, making a radio call or entering information for programming the radio's lists.

Each key can generate several different characters. For example, to enter the character "C", press the **2 abc** key three times.

Pressing **#** will toggle between the upper and lower case of the selected character.

If the next character required is on the same key, press  to move the cursor forward one character.

If an error is made, press  to delete the current character and move cursor back one character.

For full character set, refer to the following table.

Entering Characters using the Keypad

	Number of Times Key is Pressed																
Key	1	2	3	4	5	6	7	8	9	10	11	12	13	14	15	16	17
0	+	-	0	x	*	/	=	>	<	#							
1	.	1	? <i>¿</i>	!	,	@	-	&	:	“	()	‘	%	£	\$	
2 abc	A	B	C	2	Ä	Å	Ą	Á	À	Æ	ß	Ç	Ć				
3 def	D	E	F	3	É	È	Ę	Ê	Ë								
4 ghi	G	H	I	4	ì	í											
5 jkl	J	K	L	5	ı												
6 mno	M	N	O	6	Ñ	Ń	Ö	Ò	Ó								
7 pqrs	P	Q	R	S	7	Ś											
8 tuv	T	U	V	8	Ü	Ù	Ú										
9 wxyz	W	X	Y	Z	9												
*	Space																
#	Use this key to toggle between UPPER CASE and lower case of the selected character																

LCD Display and Icons

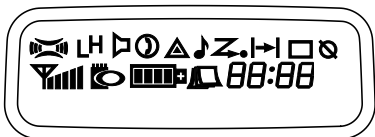











Displays channel, menu, and radio status information. The top two screen rows show radio status indicator symbols, explained in the table below:







Symbol	Name and Description
	XPAND™ Indicator Indicates that your radio has the companding feature activated.
LH	Power Level Indicator “L” lights when your radio is configured to transmit in Low Power. “H” lights when your radio is configured to transmit in High Power.
	Loudspeaker Indicator Indicates that you have the loudspeaker active.
	Scan Indicator Indicates that you are scanning for a system.
	Registered Indicator Indicates that a system has been acquired, and monitor in conventional mode.

Symbol	Name and Description
	Signal Quality Indicator Shows the radio signal quality. Five bars indicates the best signal.
	Contact List Edit Indicator Indicates user is editing the contact list.
	Data Calls List Indicator On, indicates a data call in the list Flashing, indicates new unread calls.
	Battery Level Indicator Shows the remaining charge in your battery, based on how many bars are displayed. Flashing, indicates flat battery.
	Missed Calls Indicator On, indicates there are missed calls in the missed call list. Flashing, indicates new unread calls.
	Timer Shows the call time.

Audio Signal Tones (Normal)

High pitched tone Low pitched tone

Tone	Signal	Description
Self test		Power up.
Tone A		Call clear indication.
Tone B		Traffic channel allocated or PTT/ Mic/ Loudspeaker enabled.
Tone C1		System busy.
Tone C2		Unavailable.
Tone C3		Called party busy.
Tone C4		Invalid number.
Tone D		Call set up in progress, wait for further indications.
Tone F		Transaction confirmed, called unit will call back.
Tone G		Look at display for call set up or System information.
Tone H		Invalid entry.

Tone	Signal	Description
Key click		Confidence tone when any key pressed or Speech limitation alert.
Fail tone		Hardware error or Call timed out (conventional mode).
Tone I		Low battery warning.
Tone M1		Talkgroup Confirmation.
Tone M2		Talkgroup unavailable.
Tone N1		Out of range alert.
Ring tones	Standard/ English/French/ General	Incoming call, press PTT, then wait for further indications.

Audio Signal Tones (Alternate)

High to Low pitched tones



Tone	Signal	Description
Self test		Power up.
Tone A		Call clear indication.
Tone B		Traffic channel allocated or PTT/ Mic/ Loudspeaker enabled.
Tone C1		System busy.
Tone C2		Unavailable.
Tone C3		Called party busy.
Tone C4		Invalid number.
Tone D		Call set up in progress, wait for further indications.
Tone F		Transaction confirmed, called unit will call back.
Tone G		Look at display for call set up or System information.

Tone	Signal	Description
Tone H		Invalid entry.
Key click		Confidence tone when any key pressed or Speech limitation alert.
Fail tone		Hardware error or Call timed out (conventional mode).
Tone I		Low battery warning.
Tone M1		Talkgroup Confirmation.
Tone M2		Talkgroup unavailable.
Tone N1		Out of range alert.
Ring tones	Standard/ English/French/ General	Incoming call, press PTT, then wait for further indications.

GETTING STARTED

BATTERY INFORMATION

Battery Care and Tips

This product is powered either by a nickel-metal-hydride (NiMH), or lithium-ion rechargeable battery.

The following battery tips will help you obtain the highest performance and longest cycle life from your Motorola rechargeable battery.

- Charge your new battery overnight (**14-16 hrs**) before using it to obtain maximum battery capacity and performance.
- Charging in non-Motorola equipment may lead to battery damage and void the battery warranty.
- When charging a battery that is attached to the radio, turn the radio off to ensure a full charge.
- The battery should be at about 25°C (room temperature) whenever possible. Charging a cold battery (below 10°C) may result in leakage of electrolyte and ultimately, in failure of the battery.
- Charging a hot battery (above 35°C) results in reduced discharge capacity, affecting the performance of the radio. Motorola rapid-rate battery chargers contain a temperature-sensing circuit to ensure that the battery is charged within these temperature limits.
- New batteries can be stored up to two years without significant cycle loss. Store new/unused batteries in a cool dry area.
- Batteries which have been in storage should be charged overnight.
- Do not return fully charged batteries to the charger for an “extra boost”. This action will **significantly** reduce cycle life.
- Do not leave your radio and battery in the charger when not charging. Continuous charging will shorten battery life. (Do not use your charger as a radio stand.)
- For optimum battery life and operation use only Motorola brand chargers. They were designed to operate as an integrated energy system.

Recycling or Disposal of Batteries

Motorola endorses and encourages the recycling of all re-chargeable batteries. Contact your local Motorola dealer for further information.

Charging the Battery

If a battery is new, or its charge level is very low, indicated by battery level indicator showing one or no segments, you will need to charge the battery before you can use it in your radio.

Note: Batteries are shipped uncharged from the factory. New batteries could prematurely indicate full charge, charge a new battery for 14-16 hrs before initial use.

Charger LED	Status
Red	Battery is charging
Green	Battery is fully charged
Flashing Red *	Battery is unchargeable
Flashing Yellow	Charger is getting ready to charge
Flashing Green	Battery is 90% charged

* Battery is damaged. Please contact your dealer.

1. Place the radio with the battery attached, or the battery alone, in the charger.
2. The charger's LED indicates the charging progress.

Battery chargers will charge only the Motorola authorized batteries listed below; other batteries will not charge.

Part No.	Description
JMNN4023	Lithium-Ion
JMNN4024	Lithium-Ion High Capacity
JMNN4025	NiMH Factory Mutual

ACCESSORY INFORMATION

Attaching the Battery

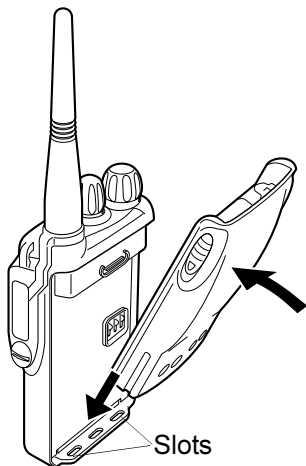

1. Fit the extensions at the bottom of the battery into the slots at the bottom of the radio's body.
2. Press the top part of the battery towards the radio until you hear a click.

Removing the Battery

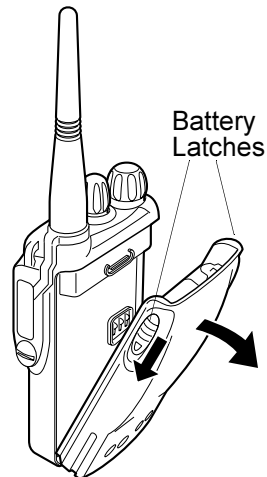

1. Turn off the radio, if it is turned on.
2. Slide the battery latches, on both sides of the battery, downwards.
3. Pull the top part of the battery away from the radio's body, and remove the battery.

Attaching the Antenna

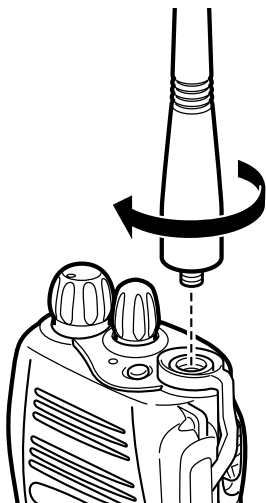

1. Align the threaded end of the antenna with the radio's antenna connector.
2. Turn the antenna clockwise to fasten it.

Removing the Antenna

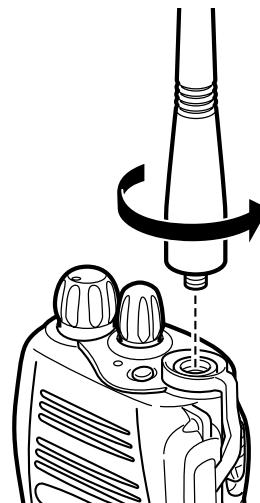

1. Turn the antenna counterclockwise until you can remove it.

RADIO OPERATION

Turning The Radio On or Off

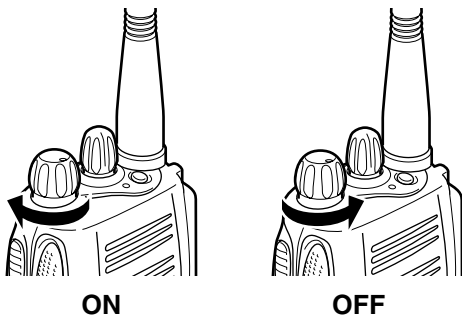

- To turn the radio on, turn the **On-Off/Volume Control** knob clockwise.
- To turn the radio off, turn the **On-Off/Volume Control** knob counterclockwise until you hear a click.

Adjusting the Radio's Volume

- Turn the **On-Off/Volume Control** knob to adjust the volume level.

Radio Registration

When turned on, the radio enters a self test routine during which time the display is activated, the self test tone will sound and the LED will light green. If the radio fails the self test a continuous low tone will sound and the display will show a failure message. e.g.

Synth Lock

until the radio is turned off .



Note: If the radio fails the self test routine, consult your dealer.

When the self test is complete the radio will display:

Freetext

This display is for the personality last used. To check the radio personality or select a new personality refer to PERSONALITY - **Personality Selection**.

After this text has been displayed, the radio will scan for system access with the LED on the top of the radio flashing GREEN and the scanning icon  lit.

When a system is acquired, the green LED will go off, the scanning icon  will be replaced by the registered icon  and the display will show:

Idle Freetext

RADIO CALLS

Making a Call

The radio is capable of making a variety of calls, including calls to individual radios, groups of radios and calls to private and public telephone systems.

Before you can make a call the radio must be in the IDLE STATE, as displayed above, i.e. a personality has been selected and no call is in progress.

The radio can make calls by using the **Contact List**, **Dedicated Calls** or **Manual Dialling**.









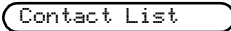

Contact List

When the radio is in the IDLE state, the contact list may be used which allows access to up to 100 preprogrammed numbers accessed via the menu.

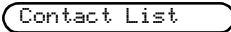
Depending on the way your radio is programmed, the radio will display either the alpha alias (name) or the number to be dialled. One of four tones may be tagged to the pre-programmed numbers, which will sound when the radio receives a call from that number.

The contact list can be entered directly by one click of the rotary knob (1) when the radio is in the IDLE STATE. Use the rotary knob to scroll through the list and select the required name or number as indicated in step 4 below. Make and end the calls as in steps 5 to 8 below.

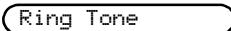
To access the contact list via the menu:

- 1  to enter Menu Mode.
- 2  or  until: 
- 3  to select: 
- 4  or  until: 



- 5  or PTT button or # to make call.

You will see: 
- 6 After the call is set-up, press PTT button and talk with your mouth 2.5-5 cm from microphone. Release PTT to listen.

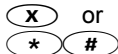
7 When finished with call.

8 CLEAR BUTTON or



Tone A sounds

Call Ended

If a contact list number is selected but no call request is sent, the display is held until tone H sounds and then reverts to the IDLE STATE.

When the number is displayed it may be edited as described in the **Keypad Edit** section.

Modifying the Contact List

You can modify the Contact List in three ways:

1. Add an entry
2. Delete an entry
3. Edit an existing entry

Note: The radio cannot receive any calls while you are modifying the contact list.

To Add an Entry

1 to enter Menu Mode.

2 or until:

3 to select:

You will see:

4 Use the keypad to enter the name (see pages 8 and 9). A maximum of 14 characters is allowed.

5 to store the name.

You will see:









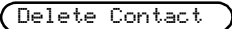

6 Use the keypad to enter the number (see pages 8 and 9). A maximum of 20 digits is allowed.

7 to store the number.

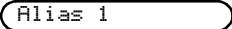

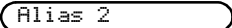







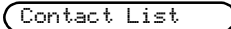

You will see:

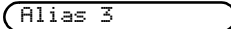

8 If you make an error, use the key to delete the last character/digit and the key to create a space.

To Delete an Entry

- 1  to enter Menu Mode.
- 2  or  until: 
- 3  to select: 
You will see current entry e.g.: 
- 4  or  (or rotary knob) until you see the entry you want to delete.
You will see e.g.: 
- 5  to select the entry
You will see: 
- 6  to delete the selected entry.
Display returns to: 

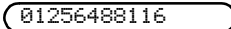
To Edit an Entry

- 1  to enter Menu Mode.
- 2  or  until: 
- 3  to select: 
- 4  or  until you see the entry you want to edit
You will see e.g.: 
- 5  for 2 seconds to enter Edit Alias Mode when display icon  flashes.
You will see selected entry e.g.: 
- 6 Use the keypad to edit the alias (see pages 8 and 9) or delete and enter a new alias. Use the  key to delete the last character or the CLEAR key to delete entire entry.
- 7  to store edited/new alias.
You will see associated number e.g.: 

- 8 Use the keypad to edit the number (see pages 8 and 9) or delete and enter a new number. Use the  key to delete the last digit or the CLEAR key to delete entire entry.
- 9  to store the edited/new entry.

Display returns to:

 Alias 3

To Search for an Entry

When in Contact List or Delete Contact menu, you may search for an alias (name) by entering characters from the keypad.



- 1 Enter up to 3 characters from the keypad e.g.:

 Pol

- 2  to start search of list:

Display shows search result e.g.:

 Police

- 3  to repeat search using same search criteria
- 4  to cancel search at any time,
or
If search unsuccessful display returns to contact list menu prior to search.







Note: The search process is not case sensitive.

User Absent







User Absent can be selected on your radio when you are unable to take calls. Any calls to your radio will be put into the Missed Calls list automatically and the message 'Will Call Back' is sent to the caller.

User Absent may be switched **on** and **off** directly by pressing the dedicated User Absent button (if programmed).

To switch **on** User Absent via the menu:

- 1  to enter Menu Mode.
 - 2  or  until:
 - 3  to select:
 - 4  or  until:
 - 5  to select:
 - 6 Followed by:
(held for 10 seconds, then display returns to idle)
 - 7 CLEAR button to exit Menu Mode.
- Display shows:

When you are able to take calls, ensure that User Absent is switched **off** by:

- 1  to enter Menu Mode.
 - 2  or  until:
 - 3  to select:
 - 4  or  until:
 - 5  to select:
 - 6 Followed by:
(held for 10 seconds, then display returns to idle)
 - 7 CLEAR button to exit Menu Mode.
- Display shows:

User Absent may be permanently enabled in your radio via programming. With this feature enabled, entry into the user absent mode is automatic and any calls received when you are away from your radio will be put into the

Missed Calls list automatically and the message “Will call back” sent to the caller.

When you return to your radio, check whether tone G sounds every 10 seconds which indicates that your radio is in user absent mode. Press any button to exit user absent mode and return the radio to the idle state for normal operation.

Dedicated Calls

Dedicated calls can be made from either a preprogrammed dedicated call button or using the speed-dial feature from the keypad.

Press the Dedicated Call button to make a call to the most commonly used pre-programmed number. The display will show “Calling”.

To use the speed-dial feature, hold down one of the keypad keys (0 to 9) for a preset period to make a call to one of ten (1 of 10) preprogrammed numbers which are the first ten entries (1 to 9, 0= 10) in the contact list.

The selected number and then the alias will be displayed and the conversation can go ahead.

Manual Dialling

To make a call from the keypad (12):

- 1 Enter Telephone Number
(PSTN calls always start with 0)
(PABX calls start with 6,7 or 8)
or
Radio ID
or
Group ID
- 2 PTT button or **#** to make radio call.

You will see:

Calling

Last Number Redial

The last number dialled by the radio is stored in the memory of the radio.

Partially entered numbers are also stored.

With the radio in the IDLE STATE:

1 PTT button 

2 PTT button or  to make radio call.

You will see: 

The number may also be edited, see **Keypad Edit** .

Last number redial does not function when Talkgroup personality is selected, see PERSONALITY - **Personality Selection**.

Keypad Edit

If the radio is displaying a Contact List number, a Keypad Dialed number, Status number or Missed Call number, the last digit may be deleted by:

For Contact List numbers

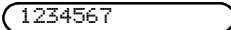
1  Once 
(to select number)

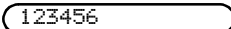
2  Again 
(to delete last digit)

For all other numbers

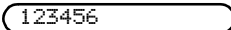
3  Once 
(to delete last digit)

4 Enter new numbers 



5 PTT button or  to make radio call.

You will see: 

Note: The edited number is not saved at the end of the call in the contact list, but is saved in the last number redial.

Ending a Call

Always end a call by:



- 1 CLEAR BUTTON or
 or

Tone A sounds

Call Ended

See "**Call Progress - Ending a Call**".

Cancelling a Call

At any time while setting up a call it may be cancelled by:

- 1 CLEAR BUTTON or
 or

Cancelling

See "**Call Progress - Cancelling a Call**".

Receiving A Call

There are two types of systems on which the radio may be used, Off Air Call Set Up (OACSU) and Full Off Air Call Set Up (FOACSU).

If you are in doubt about which system you are operating on, please consult your dealer.

Receiving a call on an OACSU system

When the radio is called:

- 1 Tone D sounds
- 2 Tone B sounds

For display Call Type see "**Call Progress - Receiving**"

Receiving a call on an FOACSU system

When the radio is called:

- 1 Ring tone sounds
- 2 PTT button or to accept call.
(Unless in talkgroup personality, when the radio unmutes automatically for dynamic and fixed group calls)
- 3 Tone D sounds
- 4 Tone B sounds (when conversation is permitted)

For display Call Type see "**Call Progress - Receiving**"

Note: The system may have a limited call time, indicated on the display, and the call may be terminated automatically if this call time is exceeded.

e.g.

Display shows:

Missed Calls

If a call remains unanswered, the call will be stored by the radio, provided that missed calls have been programmed into your radio.

Up to ten calls can be stored. If the same radio calls more than once the call is only stored once. When ten calls have been stored by the radio, the eleventh call received may overwrite the first.

When a call has been stored by the radio, tone G will sound every ten seconds, the Missed Call icon  will flash and the display will show:







Missed Calls

With the display showing 'Missed Calls', pressing any of the menu buttons provides a quick access into the Missed Calls List.

The Missed Call List can also be entered directly by pressing the Missed Call button (if programmed) when the radio is in the IDLE STATE or via the menu.

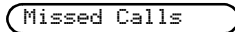
If using the Missed Call button, follow the procedures from step 4 below.

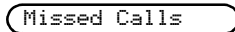
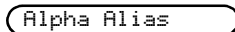
To view the calls in the list via the menu:

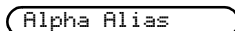
- 1  to enter Menu Mode.
- 2  or  until: 
- 3  to select: 
- 4 First call in list 
- 5  or  to scroll list: 

Note: In the Missed Calls list some alpha alias/ numbers may contain a suffix S, which indicates a status message associated with the call.

Example:

Display shows  Reception S

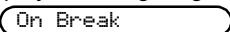

where S is a status message associated with the call

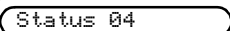
 Displays message e.g.
 On Break

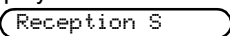
 again Displays status number
e.g.  Status 04

 again Display shows
 Reception S

You can call back to any number in the Missed Call list by:

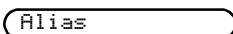
1  or  until:  Alias

2 PTT button or  # to make the call.

You will see:  Calling

3 After the call is set-up, press PTT button and talk with your mouth 2.5-5 cm from microphone. Release PTT to listen.

4 CLEAR BUTTON or

 X or

 *  #

Tone A sounds  Call Ended

5 Display shows  Idle freetext

Note: Whilst displaying alias,  will allow number to be displayed and edited.

On a successful call set-up, the entry is automatically deleted from the list together with an associated voice message.

Unanswered calls may be deleted from the Missed Call list at any time by pressing:

- 1 CLEAR button

Display shows:

Delete?

- 2 (or * # or CLEAR button) to delete missed call from the list.
- 3 X to retain missed call in list.
- 4 * # deletes the currently selected missed call with no display prompt.

On deletion of the last message in the Missed Calls list, the radio will exit the menu and return to the IDLE STATE.

To exit the Missed Call List:

- 1 X button or MISSED CALL button to exit Menu mode.

Display shows:

Idle freetext

Note: The calls in the stack are not deleted when the radio is turned off. It is not possible to call back status calls.

Call Diversion

Incoming speech calls or status calls can be diverted by:

1 * 4 ghi 1 From your radio

2 * 4 ghi 4 ghi From another radio

When the radio is in the IDLE STATE, call diversion can be initiated by:

1 * 4 ghi 1 * To divert all calls

or

* 4 ghi 4 ghi *

2 * 4 ghi 1 1 * To divert speech calls only

or

* 4 ghi 4 ghi 1 *

3 * 4 ghi 1 2 abc * To divert status/data calls only

or

* 4 ghi 4 ghi 2 abc *

4 Enter ID of radio to which you are diverting

5 # To complete call diversion

Examples:

1 * 4 ghi 1 * 2 abc 3 def 4 ghi #

Will divert all calls **from your** radio to the radio with ID "234"

2 * 4 ghi 4 ghi * 2 abc 3 def 4 ghi *
4 ghi 3 def 2 abc #

Will redirect all calls **from** the radio with ID "234" **to** the radio with ID "432"

If a call is made to a radio whose calls are currently being diverted:

1 Tone D sounds

Diverting

A call is automatically set up to the radio which is receiving the diverted calls

To cancel Call Diversion:

- 1 To cancel call diversion from your radio

4 ghi 1 followed by 1 or 2 abc if necessary and

- 2 To cancel call diversion from another radio

4 ghi 4 ghi followed by 1 or 2 abc if necessary and * "ID" (234 in example)

- 3 To cancel calls redirected to your radio

4 ghi 5 jkl followed by 1 or 2 abc if necessary and

SPECIAL CALLS

Short Data Messages (SDM)

Short data messages may be set up, sent and received using the radio keypad and controls. Outgoing data messages from the keypad are limited to alphanumeric data in any combination of up to 20 characters (which include address information and data selection characters).

Receiving Short Data Messages

On receiving a Short Data Message:

- 1 Tone G sounds

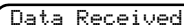

The data message icon  is lit whenever SDMs are in the data message calls list. Note that the data message icon flashes when data messages in the calls list are unread. The icon is lit permanently when a message is read and retained in the calls list.

Storing SDMs

Incoming SDMs are stored on receipt in the Short Data Message Calls List. Up to ten SDMs can be stored by the radio. The data message icon  is lit whenever SDMs are in the calls list.

SDMs are not stored when the radio is switched OFF, except for one SDM only which can be saved.













Interrogating the SDM Calls List

When an SDM call has been stored by the radio, the display will show:





With the display showing 'Data Received', pressing any of the menu buttons provides a quick access into the Data Calls List.

To view the calls in the list via the menu:

- 1  to enter Menu Mode.
- 2  or  until:
- 3  to select:
- 4 First call in list
or
- 5  or  to scroll list:
or
- 6  or  to read selected message:
- 7 At end of message:  or  to return to data calls list.
- 8  to retain message in list and exit from data messages
- 9  again to exit from Menu Mode

To save an SDM to be retained after the radio is switched off.

- 1 Read the data message in the Data Calls List.
- 2 
You will see:
- 3  to save selected message.
- 4  will not save selected message, display will return to Data Calls List.

When the radio is switched off and on again the saved SDM will appear in the Data Calls List.

Note: You must exit the data message calls list interrogate mode to put the radio in the idle state in order to make other calls.

Deleting Messages from the Data Calls List

- 1 To delete data messages from the data calls list or while viewing data messages.

- 2 CLEAR button

Display shows:

- 3 (or or CLEAR button) to delete data message from the calls list.
- 4 to retain data message in the calls list.
- 5 deletes the currently selected data message with no display prompt.
- 6 Radio returns to the data calls list interrogate mode after each deletion until the last message is deleted when the display returns to the idle state and the data message icon is extinguished.

Status/Voice Call replies to an SDM

Where an SDM contains a calling party number, the radio can respond with a status message or voice call.

To respond with a status message, from the data call list interrogate mode or data message scrolling mode, press the **Status** button. The radio will exit the data mode and enter the dialling state for example:

Display shows:

The status digits can then be specified as in normal status mode.

To respond with a voice message, use the button, to remove the status symbol **S** and press the PTT or button to initiate the call.

Display shows:

You can move directly from the Data Calls List to the Missed Calls List by pressing the Missed Calls button. Once in the Missed Calls List the functionality is as detailed in RADIO CALLS - **Missed Calls**.

Making an SDM Call

SDM Calls may be initiated in three different ways:

1. Via the keypad using a **Call modifier**
2. Via the **Contact List**

Note: The maximum data message size is limited to 20 characters which includes address information and data selection characters. Data entered via the call modifier method may be alphanumeric characters entered from the keypad.













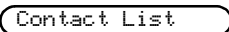

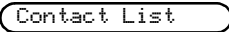

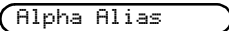

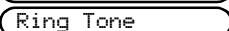

In the contact list method data may consist of alphanumeric characters which are pre-programmed into your radio by your dealer.

To initiate a data call via the **keypad**:

- 1 Part of modifier
- 2 Enter message from keypad in alphanumeric characters (ref pages 8 & 9)
- 3 Final part of modifier
- 4 Enter Called radio address
- 5 Display shows: to scroll message: (where NNNNN is called radio address.)
- 6 Press PTT button or to make a call to the dialled numbers
Tone D sounds
Display shows:
- 7 Press CLEAR button or at any time to delete dialled numbers and return radio to IDLE STATE when tone H sounds

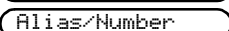
To initiate a Data call via the **contact list**

In this method data may consist of alphanumeric characters which are pre-programmed into your radio by your dealer.

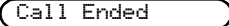
- 1  to enter Menu Mode.
- 2  or  until: 
- 3  to select: 
- 4  or  until: 
   



- 5  or PTT button to make radio call.
 Display shows: 

- 6 When finished with call.
- 7 CLEAR BUTTON or
 or
 
 Tone A sounds 

Note: The maximum data message size is limited to 20 characters which includes address information and data selection characters.

Status Calls





A status is a code for transmitting prearranged messages, e.g. status "05" may indicate "Return to Base".

Making a Status Call

Status Calls may be initiated in two different ways:

1. Via the keypad using a **Call modifier**,
2. Via the **Menu**

To initiate a status call via the keypad:

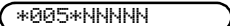
- 1   Part of modifier
- 2   Example of status digits in range 1-31
- 3  Final part of modifier
- 4 Enter Called radio address
- 5 Display shows: 

Where NNNNN is called radio address.







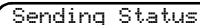







Make the call by:

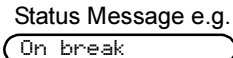

- 1 PTT button or  to make radio call.

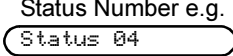
You will see:

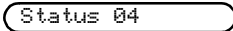
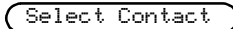

To initiate a status call via the menu:

- 1  to enter Menu Mode.
- 2  or  until: 
- 3  to select: 
- 4  or  until: 
 until: 
- 5  to select: 
- 6 Display shows for 10 seconds: 
- 7  or turn rotary knob to display: Current entry in contact list

8  or  until:
(required name or number)

9 Alternatively, a valid number can be dialled from the keypad: e.g.

10  or PTT button or  to make call.

You will see:

Note: The  key only functions when you are in the contact list menu option.

Receiving a Status Call

Your radio receives a Status Call when:

1 Tone G sounds

2 Display alternates every 2 second between:

or



and

Where Status message "04" / "On Break" is example status message. Note that only status number (04) only will be displayed if associated message is not programmed into your radio. Alias/Number is the name or number of the calling radio.

Emergency Calls

An emergency call allows you the highest form of priority calling and normally takes precedence over all other calls.

Your radio can be programmed to give you a one-button quick access to call a particular radio or centre (predefined by your dealer) in emergency situations.

Conversely you can dial the number, prefixing it with   .

To initiate an emergency call:

- 1 Press the **Emergency** button
or
- 2    followed by the radio number and PTT or .

Tone D will sound and
Display shows:

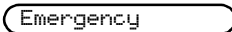

Emergency can be stopped by one of the following:

- 1 Switching the radio **Off** and **On** again.
- 2 Pressing the CLEAR button.
- 3 The emergency time duration is reached.

Note: The emergency time duration is programmed into your radio by your dealer.

Your radio may receive an emergency call when:

Tone D or Ring tone
will sound and Display
shows:

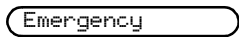

Priority Calls

A priority call allows you to gain priority over other users of the system when requesting a call.

To initiate a priority call:

1 * 8^{tuv} * followed by the number and PTT or #.

Tone D will sound and
Display shows:

Priority

See " **Call Progress - Sending**".

Broadcast Calls

A broadcast call allows you to make calls to groups of radios. Note that on a broadcast call only the calling radio can talk and there is no indication that any radios in the group have received the call.

To initiate a broadcast call:

1 * 1 1 * followed by the group number and PTT or #.

Tone D will sound and
Display shows e.g.:

*11*90

DTMF

DTMF means Dual Tone Multi Frequency and is used when the radio is required to operate in a radio system with an interface to telephone systems.

An access code, which is system dependent, is normally needed for DTMF, please contact your dealer or network manager for further information.

To initiate a DTMF call:

- 1 Enter Access code
- 2 Press and hold PTT
- 3 Enter desired number

PERSONALITY

The personalities described below are programmed into your radio by your dealer and are accessible either via the personality button or via the menu.

A radio personality contains data such as frequencies, display text, alert tones, permitted calls etc. which determines the mode of operation of your radio. Your radio may be programmed with up to 4 different personalities, selected from MPT, Talkgroup and Conventional.

MPT

This personality permits the radio to operate in a trunked mode. Incoming and outgoing calls are set up using a defined set of rules or protocol between your radio and a controller in a similar manner to your home telephone. Your radio 'registers' onto an MPT trunked system as described in GETTING STARTED - **Radio Registration**.

Talkgroup

Talkgroup is an MPT personality following the same rules or protocol, but is primarily for talkgroup calls. In talkgroup personality, talkgroups are contained in a Talkgroup list, similar to the Contact list, which is scrolled and selected using the Rotary Knob (1). On selection of a talkgroup, you may send and receive calls as described below.

Fixed and Dynamic Groups

These groups form part of the **Talkgroup Personality**, such that when this personality is selected your talkgroup list shows only these groups.

A **fixed** group is a group of users, the address (number / alias) of which is preprogrammed into your radio by your dealer.

A **dynamic** group is a group of users, the address (number) of which is sent to your radio 'over air' at any time via the system controller.

Therefore at any time you may become a member of a dynamic group, able to receive calls and (depending on how your radio is programmed) send calls to that group.

Incoming calls to fixed and dynamic group numbers are detailed in **Receiving a Call** and displayed under **Call Progress - Receiving**.

To make an outgoing call to a selected talkgroup, press the PTT and speak after the confidence tone.

Calls are cleared in the normal manner.

If the system is busy an engaged tone will be heard, release the PTT and wait for the confidence tone. You may then proceed with the call by pressing the PTT.

When in Talkgroup personality, you can still make an individual or status call using the keypad or entering the Contact List via the menu as detailed in RADIO CALLS - **Contact List**.

Conventional Mode

In the conventional mode your radio operates as a standard two-way radio.

Select the personality "Conventional" as described in **Personality Selection**, the display shows:



Channel xx

where xx is the channel number. Use the rotary knob (1) to display and select the desired channel.

Prior to transmission always make sure that the channel is free (red LED not flashing). Press the PTT (4) to transmit, release to listen. The red LED lights while the radio transmits and flashes if the channel is busy.

Some channels may be monitored for activity by pressing the clear button (3). The  icon will be displayed until the channel is changed or the clear button is pressed again.







In the conventional mode, the radio is equipped with a time out timer. A speech limitation alert tone will sound a few seconds before the transmitter in your radio is switched off. The call timed out tone will sound and continue until the PTT is released.

To generate DTMF tones, press and hold the PTT while entering the desired number.

Personality Selection

Personality selection may be entered directly by pressing the Personality button (5). You may then scroll using the rotary knob and select a personality as described in step 7 below, or scroll and select a personality as described from step 6 below.

To select a personality via the menu:

- 1 Ensure radio is in IDLE STATE.
- 2  to enter Menu Mode.
- 3  or  until:
- 4  to select:
- 5 Display shows current personality e.g.:
- 6  or  until desired personality e.g.:
- 7  to select:

- 8 The display will be held for 2 seconds while your radio retunes to the new personality.

Your radio will return
to the idle state:

Freetext

CALL PROGRESS

When in operation, your radio monitors each step in setting up a call whether sending or receiving. These steps are displayed to provide you with call progress and indicate call types.

Call Progress - Sending

Tone	Display	Comment
D	Calling	Trying to connect call
D	Priority	Priority call sent, modifier *8* used
D	Emergency	Emergency call sent, modifier *9* used
D	Sending Status	Status call sent, modifier *0xx* used (xx is status message number)
G/D	Queued	Call queued on system
D	Diverting	Calls to called unit have been diverted
C2	Unobtainable	Call unobtainable

C2	Unavailable	Unit unavailable
C4	Invalid Number	Unit number invalid
C1	System Busy	System busy, try again
D	Alerting	Alerting called unit
C3	Engaged	Called unit is busy
F	Will Call Back	User absent, called unit will call back
C2	Call Failed	Call failed, try again
C2	Timeout	Call request timed out. Check service is available
H	Scanning	System access lost, try again

Call Progress - Receiving

Tone	Display	Comment			
D	Caller ID	A call is being received on OACSU	B	Talkgroup NN	Talkgroup call received (NN is list number)
Ring Tone	Caller ID	A call is being received on FOACSU . Press PTT or '#' to accept the call	B	Dynamic NN	Dynamic group call received (may be alias or number - NN)
D/ Ring Tone	Emergency	Emergency call being received	B	Group NN	Fixed group call received (may be alias or number - NN)
B	Alias/Number	Call from radio in your fleet	B	System Wide	Call to all radios in use on the system
B	Interfleet	Call from radio in another fleet	B	Broadcast	broadcast call received, user reply not permitted
B	Telephone	Calls from public telephone system	G	Status XX	Receiving status message (xx is status message number)
B	PABX	Calls from private telephone system			
B	Unknown Party	Call identity unknown to the system			

Call Progress - Cancelling a call

Tone	Display	Comment
D/G	Cancelling	Call successfully cancelled by user

Call Progress - Ending a call

Tone	Display	Comment
A	Call Ended	Call ended, another call can now be made

NOTES